

TIPS & TRICKS

TAU 128MA

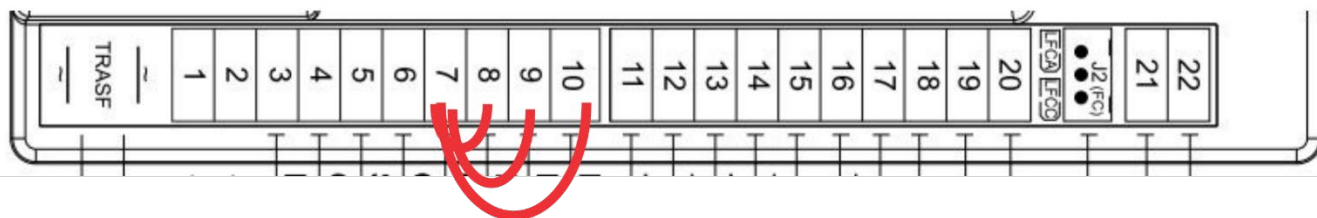

- **TIP** – You need solid opening and closing stops. The control board will search for these when programming. Make sure they have no movement or flex.
- **TIP** – You need to fit three small loops of wire to your safety inputs to make anything work. These can be removed later if you install safety devices to these input terminals. But for now, take three pieces of light gauge wire (speaker or telephone wire is good) about 50mm long and strip both ends 7mm and insert them as above from 7 to 8, 7 to 9 and 7 to 10.
 - **TIP** – The STOP input will not seal unless you have the manual override handle closed.
- **TIP** – To program and to run all safety inputs need to be sealed. The LED lights 5,6,7 and 8 should all be lit green. (Not so when solar powered)
 - **TIP** – Start with all dip switches in the off position. You can adjust these to suit later.
- **TIP** – Do not install any accessories until after you have programmed the unit and have it operating as you would like. You can then add each accessory one at a time.
- **TIP** – If using solar power refer to the manual for correct input power connection. When solar powered the logic automatically enters power save mode and only LED 1&2 will work.

QUICKSTART

1. Ensure you have followed the instructions above and that you have the four green LED lights lit.
 2. Carefully turn trimmer V-RAL anti clockwise until it comes to a stop. (Do not force)
 3. Release the gate and position it 500mm from the fully open stop.
 4. Press the PROG button and hold until DL2 LED starts flashing orange. Release the button.
5. The gate should start to open slowly to find the open stop. If the gate closes instead remove power, change the polarity of the motor by swapping terminals 23 and 24 and start again from point 3.
 6. When the opening stop is found the gate will close slowly searching for the closing stop.
7. When the closing stop is found the gate will complete a full open and close before exiting program mode of working times.
8. If using remote controls press and release quickly CH1. Green LED2 should light to indicate ready.
9. In the next ten seconds press for one second and release one of the buttons on your remote control. The green LED turns off and on again waiting for further remote controls.
10. When you have programmed all remote controls simply wait ten seconds until DL2 goes out.
 11. Test your install.
12. You can now make adjustments and connect accessories one at a time and test each time.

K128MA

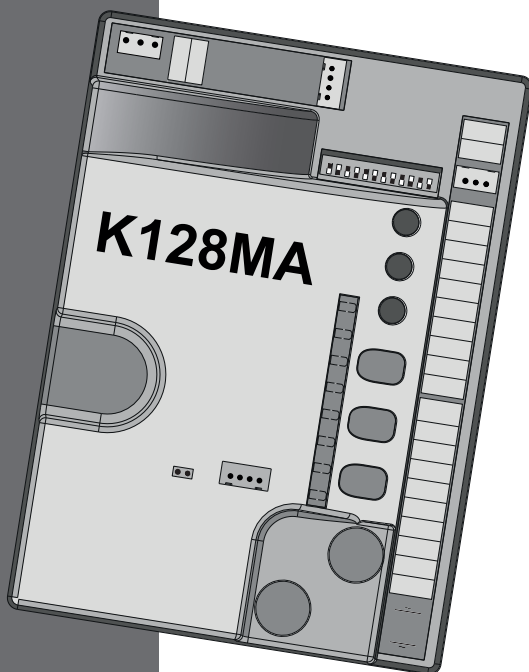

Ver. Firmware 9.05

D-MNL0K128MA 28-03-2023 - Rev.03

IT - Istruzioni originali



MADE IN
ITALY



K128MA WIRING DIAGRAM

K128MA



Trimmer:

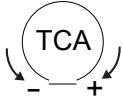
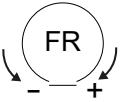

LEDs:

- DL8 FIXED SAFETY EDGE
- DL7 EXT. PHOTO
- DL6 INT. PHOTO
- DL5 STOP
- DL4 OPEN/CLOSE
- DL3 PEDESTRIAN
- DL2 ERRORS
- DL1 BATT

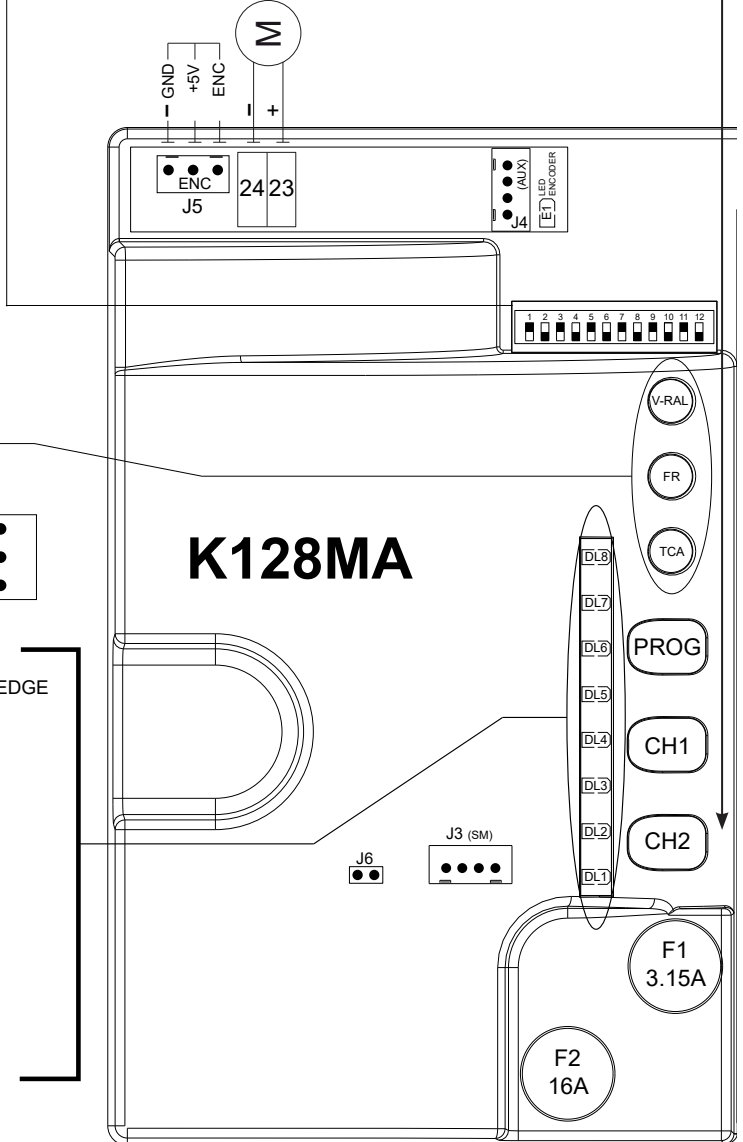



- Terminals 1 - 2: Careful NOT to invert polarity.
- If Jumper J6 is plugged in, energy saving mode will be activated and, at the end of each manoeuvre, outputs 11-12, 12-13, 14-15, 16-17 and 16-18 will be switched off.

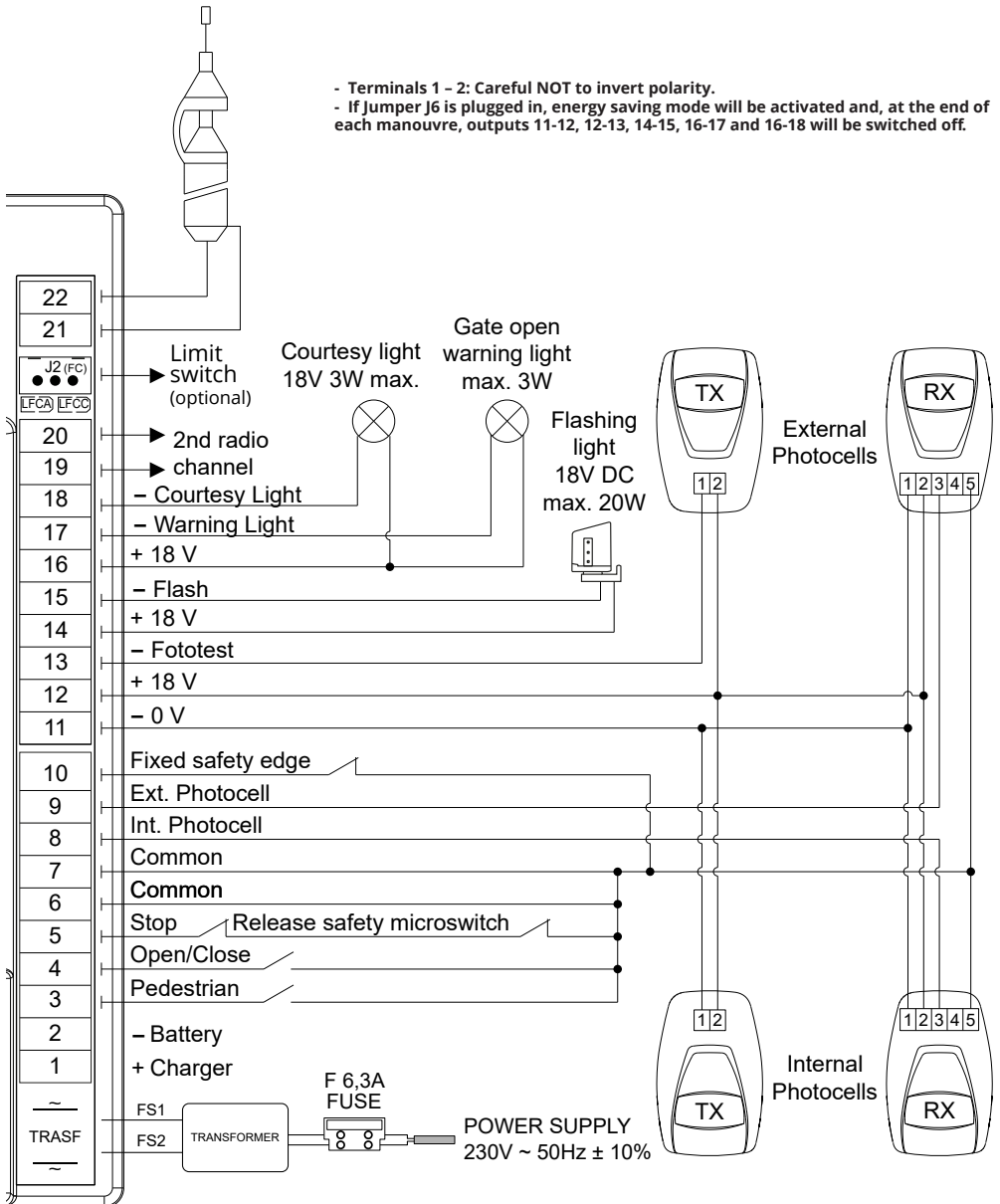

K128MA

CONNECTION OF BATTERY CHARGER + BATTERY (OPTIONAL)

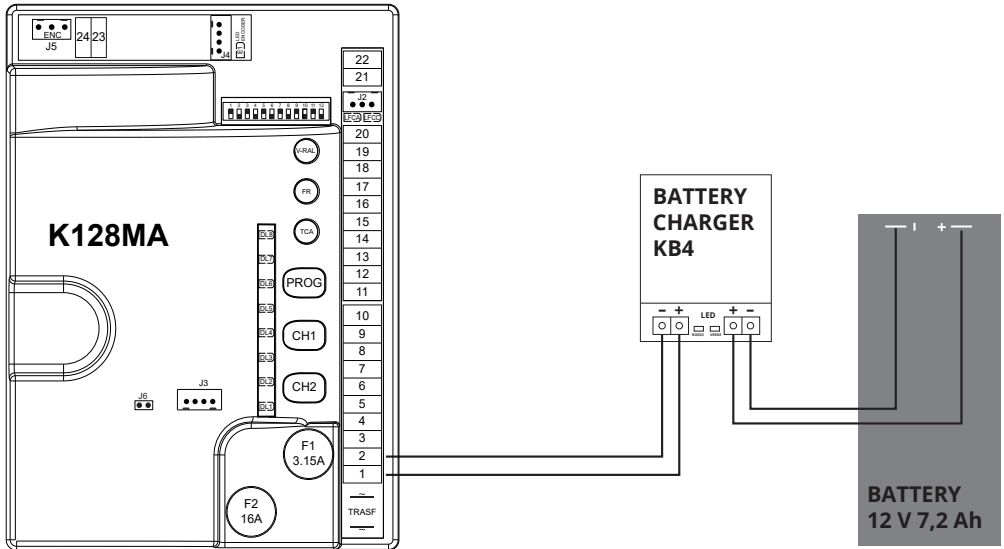

To ensure the gate operation during a power failure, the KB4 kit (battery charger + battery 12V 7.2Ah) can be used to connect to the control unit as shown in the diagram above.

NOTICE: the battery cannot be connected directly to terminals 1-2 of the control unit.

CONNECTION OF SOLAR PANEL + ADJUSTMENT BOARD + BATTERY (OPTIONAL)

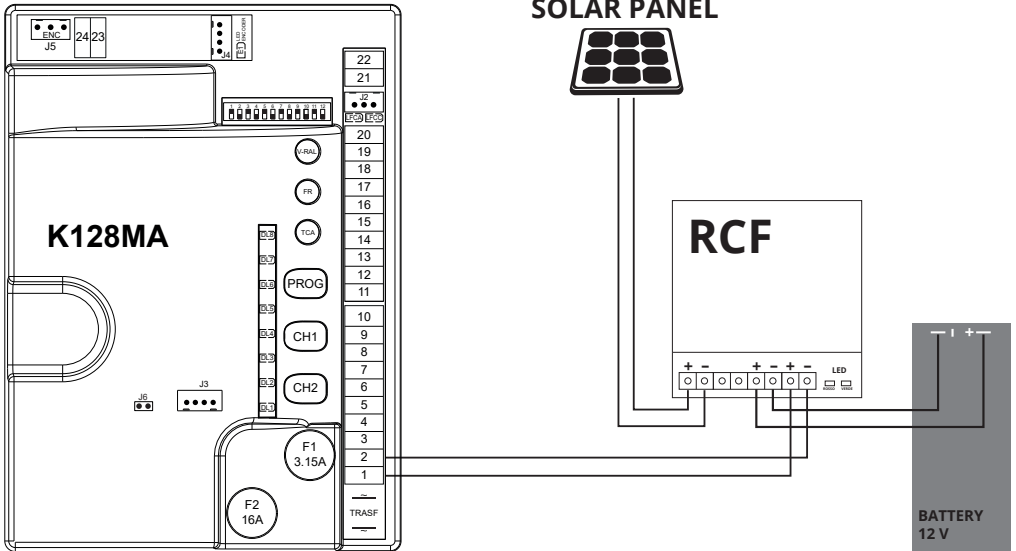

If you do not have the mains voltage to power the gate automation and you want to use renewable energy, you can connect a photovoltaic panel + adjustment board + 12V battery to the automation control unit as shown in the diagram above.

WARNINGS

This manual is designed to assist qualified installation personnel only. It contains no information that may be of interest to final users. This manual is enclosed with control unit and may therefore not be used for different products!

Important warnings:

Disconnect the mains power supply to the board before accessing it.

The control unit has been designed to control an electromechanical gear motor for automating gates and doors of all kinds.

Any other use is considered improper and is consequently forbidden by current laws.

Please note that the automation system you are going to install is classified as “machine construction” and therefore is included in the application of European directive 2006/42/EC (Machinery Directive).

This directive includes the following prescriptions:

- Only trained and qualified personnel should install the equipment;
- the installer must first make a “risk analysis” of the machine;
- the equipment must be installed in a correct and workmanlike manner in compliance with all the standards concerned;
- after installation, the machine owner must be given the “declaration of conformity”.

This product may only be installed and serviced by qualified personnel in compliance with current, laws, regulations and directives.

When designing its products, TAU observes all applicable standards (please see the attached declaration of conformity) but it is of paramount importance that installers strictly observe the same standards when installing the system.

Unqualified personnel or those who are unaware of the standards applicable to the “automatic gates and doors” category may not install systems under any circumstances.

Whoever ignores such standards shall be held responsible for any damage caused by the system!

Do not install the unit before you have read all the instructions.

INSTALLATION

Before proceeding, make sure the mechanical components work correctly. Check that the gate slides freely on a horizontal plane (gates that open / close on sloping floors can affect the operation and duration of the control unit and the gearmotor).

Then make sure that the power consumption of the gear motor is not greater than 3A (otherwise the control panel may not work properly). Having followed the previous points, now make sure the motor has a proper absorption.

THE EQUIPMENT MUST BE INSTALLED “EXPERTLY” BY QUALIFIED PERSONNEL AS REQUIRED BY LAW.
Note: it is compulsory to earth the system and to observe the safety regulations that are in force in each country.

IF THESE ABOVE INSTRUCTIONS ARE NOT FOLLOWED IT COULD PREJUDICE THE PROPER WORKING ORDER OF THE EQUIPMENT AND CREATE HAZARDOUS SITUATIONS FOR PEOPLE. FOR THIS REASON THE “MANUFACTURER” DECLINES ALL RESPONSIBILITY FOR ANY MALFUNCTIONING AND DAMAGES THUS RESULTING.

1. CONTROL PANEL FOR ONE 18 V MOTOR WITH ENCODER

- STATUS OF INPUTS SIGNALLED BY LEDs
- INCORPORATED FLASHING CIRCUIT
- ENCODER SENSOR FOR SELF-LEARNING OF TRAVEL
- 433.92 MHz 3 CHANNEL BUILT-IN RADIO RECEIVER (CH)
- DIAGNOSTICS OF MALFUNCTIONS SIGNALLED BY LED
- POSSIBILITY OF ENERGY SAVING OPERATION
- COMPATIBILITY WITH OUR APPS: TAUOPEN AND TAUAPP

ATTENTION:

- do not use single cables (with one single wire), ex. telephone cables, in order to avoid break-downs of the line and false contacts;
- do not re-use old pre-existing cables;
- In case of long sections of cables (> 20 m) for N.O./N.C. controls (e.g. OPEN / CLOSE, STOP, PEDESTRIAN, etc.), in order to avoid gate malfunctions, it will be necessary to uncouple the various controls using RELAYS or using our 750T-RELE device.

2. INTRODUCTION

The K128MA board has two working modes, selectable through the J6 jumper (see wiring diagram).

- J6 Not jumped:** standard mode, i.e. the control unit is powered all the time;
- J6 Jumped:** low consumption mode, at the end of each maneuver the board automatically switches OFF itself and all the auxiliary devices connected. The board will automatically switch ON again activating the OP/CL contact or pressing the remote (mode where power is supplied by other energy sources, ex. batteries charged by a photovoltaic panel). In this way, the DL1 and DL2 LEDs flash every 4 seconds.

Once the connection is achieved, in low-energy mode, press the PROG button briefly:

- All the green LEDs must be on (each of them corresponds to a Normally Closed input). The go off only when the controls to which they are associated are operated.
- All the red LEDs must be off (each of them corresponds to a Normally Open input). The light up only when the controls to which they are associated are operated.

3. TECHNICAL CHARACTERISTICS

Board power supply	13,5 V AC - 50 Hz
Max. absorption DC motor	250 W - 18 V DC
Fast acting fuse for protection of input power supply 13,5V AC (F4 - 5x20)	F 16A
Fast acting fuse for protection of auxiliary circuits 18V DC (F3 - 5x20)	F 3.15A
Motor power supply circuits voltage	18 V DC
Auxiliary device circuits supply voltage	18 V DC
Logic circuits supply voltages	5V DC
Operating temperature	-20 °C ÷ +55 °C

4. CONNECTIONS TO TERMINAL BOARD

Terminals	Function	Description
FS1 - FS2	POWER SUPPLY	Board supply input 13,5 V AC – Powered by the toroidal transformer housed and protected by a fuse (F 6,3A) on the 230 V AC power supply.  For low power connection: First connect the power supply given by the transformer and then by the battery (terminals 1-2)
1 - 2	EXTERNAL POWER	External power input (ex. Photovoltaic system 12V DC or battery 12V DC). Notice: battery charger board not integrated.
3 - 6	PEDESTRIAN	N.O. input for PEDESTRIAN button - Controls partial opening and closing (1/3 of the complete journey) and it is subject to the setting of DIP SW 2 and 4. (3= PED - 6= COM)
4 - 6	OPEN/CLOSE	OPEN/CLOSE button N.O. input – Controls the opening and closing of the automation and is regulated based on the function of dip-switches 2 and 4. (4= O/C - 6= COM)

5 - 6	STOP	STOP button N.C. input - Stops the automation in any position, temporarily preventing the automatic closure, if programmed. (5= STOP - 6= COM) NOTE: A safety micro-switch is connected to the STOP push-button. In case the STOP input remains open for more than 5 seconds, the operator will perform a cycle at a slow speed to reset the operating parameters to the values originally saved (see "Restoring automatic operation"). The micro-switch should be connected in series to further STOP push-buttons where present.
7 - 8	INTERNAL PHOTOCELLS	PHOTOCELL OR SAFETY DEVICE input INSIDE the gate (Normally Closed contact). When these devices trigger during the opening phase, they temporarily stop the gate until the obstacle has been removed; during the closing phase they stop the gate and then totally open it again. Bridge the connectors if not used. (7= COM - 8= CLOSE)
7 - 9	EXTERNAL PHOTOCELLS	PHOTOCELL OR SAFETY DEVICE input OUTSIDE the gate (Normally Closed contact). Then these devices trigger during the closing phase, they stop the gate and then totally open it again. Bridge the connectors if not used. (7= COM - 9= FOT) Note: the photocell transmitter must always be supplied by terminals no. 12 and no. 13, since the safety system test (phototest) is carried out on it. Without this connection, the control unit does not work. To override the testing of the safety system, or when the photocells are not used, set dip-switch no. 6 to OFF.
7 - 10	SENSITIVE EDGE	SAFETY EDGE input (Resistive sensitive edge 8,2 K Ω or with n.c. contact - see DIP SWITCH 12).It works during the opening phase and also during the closing phase, resulting in the temporary stop of the automation and: - the partial inversion of its movement for 20 cm (only in the opening phase) - the complete opening (only in the closing phase); thus freeing any obstacle. NOTE: if a resistive sensitive edge 8,2 KΩ is connected, set dip-switch no. 12 to ON; If a fixed safety edge with NC contact is connected, set dip-switch no. 12 to OFF; Jumper terminals if not used. (7= COMMON - 10= SENSITIVE EDGE)
11 - 12	PHOTOCELLS	output 18 V DC max. 15 W per photocells (TX/RX) and auxiliaries (11 = NEGATIVE - 12 = POSITIVE)
12 - 13	TX PHOTOCELLS	output for the 18 V DC transmitter photocell with the possibility of carrying out the phototest (with DIP 6 ON). (12= POSITIVE - 13= NEGATIVE)
14 - 15	FLASHING LIGHT	18V DC max. 20W output for flashing light supply, flashing signal supplied by the control unit, rapid for closing, slow for opening. (14= POSITIVE - 15= NEGATIVE)
16 - 17	GATE OPEN LIGHT	Output for OPEN GATE LIGHT 18 V DC, 3 W max; while the bar opens the light flashes slowly, when the bar is open it stays on and while closing it flashes at twice the speed. (16= POSITIVE - 17= NEGATIVE)
16 - 18	COURTESY LIGHT	18 V DC, 15 W Output for auxiliary courtesy light. It comes on with the control pulse and stays ON until after the manoeuvre for a time settable through TauApp (default = 20 sec.) (16=POSITIVE - 18= NEGATIVE)
19 - 20	2 nd CH RADIO	2 nd radio channel output - for control of an additional automation or for switching on lights, etc... (N.O. clean contact) Warning: to connect other devices to the 2nd Radio Channel (area lighting, pumps, etc.), use an additional auxiliary relay (see note at end of paragraph). WARNING: the default outlet is active monostable 2 sec. To switch it to active bistable or to modify the activation time it is necessary to use the T-WIFI.
21 - 22	AERIAL	Plug-in radio-receiver aerial input , for 433.92 MHz receivers only. (21= GROUND - 22= SIGNAL)
23 - 24	MOTOR	Motor supply output 18V DC max. 200W. (23= POSITIVE - 24= NEGATIVE)

J2 (FC)	<i>OPTIONAL LIMIT SWITCHES</i>	Quick coupling for connection for limit switches. Notice: connect/disconnect the limit switches with the control unit disconnected. It is advisable to wait 10 seconds before powering up the control unit again.
J3 (SM)	<i>MEMORY CARD</i>	Quick plug-in for MEMORY CARD connection for transmitters codes.
J4	<i>AUX</i>	Quick coupling for the connection of the T-WIFI and T-CONNECT devices
J5	<i>ENCODER</i>	Quick plug-in for ENCODER. Blue= 0 Vcc (- GND), brown= 5 Vcc (+5V), white= ENCODER SIGNAL (ENC);
J6	<i>ENERGY SAVING MODE</i>	Quick plug-in for ENERGY SAVING MODE attivazione. Once activated, at the end of each manouvre, outputs 11-12, 12-13, 14-15, 16-17 and 16-18 will be switched off.

IMPORTANT:

- do not power up auxiliary relays or other devices through the 18V DC output (terminals 11 - 12) to avoid malfunctions of the control unit. Use separated power supply / transformers instead;
- do not connect switching feeders or similar apparatus close to the automation that may be a source of disturbance.

5. LOGIC ADJUSTMENTS

Make the logic adjustments.

Note: when any adjusting devices (trimmers or dip-switches) on the control panel are operated, a complete manoeuvre must be carried out in order for the new settings to take effect.

TRIMMER

V-RAL adjusts the automation deceleration speed during the final section of the stroke;



Note: When memorizing the stroke, set the TRIMMER RALL fully turned counterclockwise (minimum deceleration speed).



FR. obstacle detection sensitivity adjustment.



Note: by rotating the TRIMMER FR. clockwise the sensitivity of the gearmotor to obstacles diminishes and therefore the thrust force increases; vice-versa, by rotating it counter-clockwise, the sensitivity of the gearmotor to obstacles increases and therefore the thrust force diminishes.



Beyond a certain threshold, the TRIMMER FR inhibits the detection of obstacles. This is signaled during the maneuvers by 7 orange flashes of the DL2



T.C.A. Automatic Closing time adjustment: from about 1 to 120 seconds (see dip-switch no. 1);

Dip switch

1	<i>AUTOMATIC CLOSING</i>	On	when completely open, closure is automatic after the set time on the T.C.A. trimmer has past.
		Off	the closing manoeuvre requires a manual command.
2	<i>2 / 4 STROKE</i>	On	when the automation is operating, a sequence of opening/closing commands causes the automation to OPEN-CLOSE-OPEN-CLOSE, etc.
		Off	in the same conditions, the same sequence of commands causes the automation to OPEN-STOP-CLOSE-STOP-OPEN-STOP, etc. (step-by step function) (see also dip switch 4).
3	<i>CLOSES AGAIN AFTER THE PHOTOCELL</i>	On	after the photocell is activated (input 7 - 9), the automation closes automatically after 5 seconds.
		Off	function off.

4	NO REVERSE	On	the automation ignores the closure command during opening and auto-close time
		Off	the automation responds as established by dip switch No. 2.
5	PRE-FLASHING	On	the pre-flashing function is enabled.
		Off	the pre-flashing function is disabled.
6	FOTOTEST	On	the "photocell test" function is enabled.
		Off	the "photocell test" function is disabled. Note: to be used when the photocells are not used.
7	MASTER/ SLAVE	On	enables the MASTER mode in the master/slave configuration (see T-COMM instructions).
		Off	enables the standard operation (single motor) or SLAVE mode in the master/slave configuration (see T-COMM instructions).



To carry out the memorization, leave DIP SWITCH 7 on OFF.

8	WITH LIMIT SWITCHES: SELECTION TOWARDS OPENING	On	operation for leaf with opening to the left (operator side); Attention: the limit switch LEDs (LFCA and LFCC) are inverted
		Off	operation for gate with opening to the right (gearmotor side);
8	WITHOUT LIMIT SWITCHES: BACK JUMP	On	once the mechanical stop of the closing maneuver is reached, the automation makes a slight movement in the opposite direction to avoid jamming between the rack and the pinion. (Editable with TauApp)
		Off	function deactivated



To change the position of Dip 8, the power must be disconnected. Once modified, rerun the SetUp of the stroke

9-10-11 NOT USED = keep in OFF

12	SENSITIVE EDGE	On	RESISTIVE SENSITIVE EDGE 8,2 KΩ (terminal No. 10).
		Off	NC CONTACT SENSITIVE EDGE (terminal No. 10). Note: if not used, keep the DIP in the OFF position.

6. MEMORIZATION PROCEDURE OF THE STROKE

WARNING: After powering the control panel, wait 2 seconds before you start performing the adjustment operations and check:

- The Input connections: all green DL5, DL6, DL7, DL8 must be on steady.
- The mechanical stops of the automation must be installed and adjusted both in opening and in closing [see motor instructions].



IMPORTANT: Carry out the first stroke memorization with the RAL trimmer positioned fully turned counterclockwise (minimum deceleration speed).

- If the gate fails to move forward during the stroke memorization procedure, it is possible to increase the speed using the CH1 (= - minus) and CH2 (= + increase) keys. To adjust the speed, briefly press the buttons.

N.B. : The speed changes made during this phase using the CH1 and CH2 keys are not permanent (valid only to memorize the stroke).

Remember to decrease the speed through CH1 during the closing/opening stop phase as there is a risk that the gate will slam the mechanical stop.

PROCEDURE WITHOUT LIMIT SWITCHES INSTALLED:

1. Start the procedure with the gate at approx. 0.5 m from the mechanical opening stop.



If the automation closes instead of opening, stop the run of the gate (by cutting the photocells or closing the STOP contact), invert the polarity of the motor, take the gate at approx 0,5 m from the mechanical stop) and restart the procedure from the beginning.

Make sure you don't stand near the automation during saving.

2. Press without releasing the PROG button (6 sec. ca.) till the DL2 LED starts flashing (orange);
3. The automation starts to open slowly in search of the opening stop;
4. Once the opening stop is reached, the automation slowly starts closing in search of the closing stop;
5. **Choice of the deceleration point in opening:**
 - The automation will start to open quickly, press therefore the PROG key to start the deceleration phase in opening at the selected point.
 - (If it is not pressed, in any case the automation slows down starting from a minimum safety distance to prevent the gate from banging hard when opening).*

6. Choice of the deceleration point in closing:

- After a short pause the automation will begin to close quickly, press therefore the PROG key to start the deceleration phase in closing at the selected point.
- (If it is not pressed, in any case the automation slows down starting from a minimum distance of safety to prevent the gate from banging strongly when closing).*

PROCEDURE WITH LIMIT SWITCHES INSTALLED:

1. Start the procedure with the gate at approx. 0.5 m from the opening limit switch.

If the automation closes instead of opening:



1. **stop the gate stroke (through photocells or by pressing the STOP key)**
2. **remove the power supply to the electronic board and reverse the direction of the gate using the DIP SWITCH n. 8**
3. **Before to restore the power to the electronic board, attend 10 seconds**
4. **repeat the programming by pressing the PROG key (6 sec. ca.) until the automation starts to open**

2. Press without releasing the PROG button (6 sec. ca.) till the DL2 LED starts flashing (orange);
3. The automation starts to open slowly in search of the opening limit switch;
4. Once the opening limit switch has been reached, the automation slowly begins to close in search of the closing limit switch;

5. Choice of the deceleration point in opening:

- The automation will start to open quickly, press therefore the PROG key to start the deceleration phase in opening at the selected point.
- (If it is not pressed, in any case the automation slows down starting from a minimum safety distance to prevent the gate from banging hard when opening).*

6. Choice of the deceleration point in closing:

- After a short pause the automation will begin to close quickly, press therefore the PROG key to start the deceleration phase in closing at the selected point.
- (If it is not pressed, in any case the automation slows down starting from a minimum distance of safety to prevent the gate from banging strongly when closing).*

- HOW TO CHANGE THE DECELERATION POINTS

If you want to change the deceleration start points, just press again the PROG key briefly (1 sec.) and the automation will start to open again and will allow you to insert the new deceleration point in opening and closing by pressing the PROG key again in the desired points.

WARNING:

- **During the memorization, the intervention of the safety devices (photocells, sensitive edge or stop input) stop the automation and pause the procedure itself; to resume, it will be necessary to press only and exclusively the PROG button.**



Please remember that an obstacle during saving is interpreted as a mechanical limit stop (the system does not start any safety operation, it just stops the motor)

7. K128MA CHARACTERISTICS

TIMER-OPERATED OPENING AND CLOSING CYCLES

The opening/closing of the automation can be controlled by means of a timer that has a free N.O. output contact (relay). The timer must be connected to terminals 4 - 6 (OPEN/CLOSE button) and can be programmed so that, at the desired opening time, the relay contact closes until the desired closing time (when the timer's relay contact opens, enabling the automatic closing of the gate).

Note: the automatic closing function must be enabled by setting Dip-switch no. 1 to ON).

OBSTACLE DETECTION

If the obstacle detection function (adjustable through FR trimmer) is activated during an opening manoeuvre, the gate closes approx. 20 cm., if it is activated during a closing manoeuvre, the gate opens all the way .



WARNING: the control panel logics may interpret mechanical friction as an obstacle.

8. LED DI DIAGNOSI

LED - DL1

Apart from highlighting the presence of the battery, LED DL1 displays any mistakes with a series of pre-set flashes in various colours:

Key:

● led always on;	○ led flashing;
● Always on (green):	main voltage present;
○ 1 flash every 4 seconds (green):	no main voltage; power supply through battery/photovoltaic panel
	<i>Check the main voltage and the fuse F2</i>

LED - DL2

The DL2 LED indicates mistakes in the board logic with a series of pre-set flashes in different colours:

Key:





● led always on;	○ led flashing;
○ 1 flash every 4 seconds (green):	normal operation;
○ / ● alternate flashing: (red/green)	saving to be performed;
○ alternate fast flashing ● / ○ : (green/orange)	Update stroke - deceleration points;
	<i>See the section "HOW TO CHANGE THE DECELERATION POINTS" in paragraph 6</i>
○ Fast (orange) flashing:	saving in progress;
○ 1 (red) flash:	phototest error
	<i>Disable phototest (dip-switch 6 OFF), check the operation of the photocells and their connection;</i>
○ 1 (orange) flash:	unknown status, next operation REALIGNMENT;
○ 2 (red) flashes :	obstacle for motor;
	<i>Make sure there are no obstacles across the path of the gate and that it slides smoothly;</i>
	<i>With an active automatic closing feature, after the intervention meant to detect the obstacle, the automatic closing is deactivated. A command pulse is required to carry out the closing;</i>

3 (red) flashes :	no motor encoder signal; <i>Check wiring, check encoder by TEST-ENCODER (optional); Check the correct flashing of led E1 *</i>
4 (red) flashes:	no motor signal; <i>Check wiring, check the motor rotates freely and is powered directly by the battery;</i>
5 (red) flashes :	max current limit for motor exceeded; <i>Excessive absorption peaks of the gearmotor, check there are no obstacles on the automation path, check the current absorption of the motor when in a no-load condition and when applied to the gate,</i>
6 flashes (orange):	master/slave communication error; <i>Check wiring between the controllers, efficiency of slave controller (fuses), efficiency of interface boards;</i>
7 flashes (red):	Sensitive edge safety intervention <i>A command pulse is required to carry out the closure;</i>
7 (orange) flashes:	Obstacle detection disabled. This signal occurs only during maneuvers.
8 (red) flashes:	Eeprom external memory fault; <i>Replace the external memory module;</i>
8 (orange) flashes:	Eeprom data error (internal/external); <i>Perform procedure RADIO MEMORY RESET;</i>

Apart from the logic mistakes, the DL2 LED indicates also the status of the control unit during the saving of the radio controls.

always on (green):	channel CH1 waiting to be saved;
5 quick flashes (green):	CH1 channel memory full;
always on (Orange):	channel CH2 waiting to be saved;
5 quick flashes (Orange):	CH2 channel memory full;
always on (red):	channel CH3 waiting to be saved;
5 quick flashes (red):	CH3 channel memory full;
flashing (green):	CH1 channel waiting to be cancelled;
always on (green):	cancelling of channel CH1 in progress;
flashing (Orange):	CH2 channel waiting to be cancelled;
always on (Orange):	cancelling of channel CH2 in progress;
flashing (red):	CH3 channel waiting to be cancelled;
always on (red):	cancelling of channel CH3 in progress;

When LEDs DL1 and DL2 flash at the same time they indicate:

flashing  +  : (Green + Red)	factory reset procedure waiting for confirmation;
flashing  +  : (Green + Orange)	waiting for total cancellation of the radio channels;

DL3 - Red	PEDESTRIAN button LED signal
DL4 - Red	OPEN/CLOSE button LED signal
DL5 - Green	STOP button LED signal
DL6 - Green	INTERNAL PHOTOCELLS LED signal

DL7 - Green	EXTERNAL PHOTOCELLS LED signal
DL8 - Green	SENSITIVE EDGE LED signal

Multiple errors are signalled by a 2-second pause between signals.

Should the encoder (obstacle detection) activates while closing, the controller will reverse the direction and slowly open until the leaf reaches its fully opened position. Auto Close function will be deactivated until a further command pulse is given. In case of 5 consecutive safety interventions the controller will progressively increase the Auto Close delay. Once the closing has been successfully achieved, the Auto Close delay will go back to standard setting.

*LED ENCODER:

E1 - Red	ENCODER OPERATION signaling LED. During the gate stroke, the LED flashes red. The flashing varies according to the motor speed.
-----------------	---

OPTIONAL LIMIT SWITCH LEADS:

The LEDs are steady on as long as the gate is moving, while one of the two LEDs switches off when:

LFCA - off	the LED signals the arrival at the opening limit switch
LFCC - off	the LED signals the arrival at the closing limit switch

9. RESTORING AUTOMATIC OPERATION

Should the Bar need to be operated manually, use the release system. After the manual operation:

- after a Mains Power Failure, such as a black-out (controller remains disconnected for a certain time) or after a manual release (without power shortage to the controller for more than 5 seconds), the automation will be moving slowly to allow the Controller to establish its Limits (REALIGNMENT procedure).

10. 433.92 MHz BUILT-IN RADIO RECEIVER

The radio receiver can learn up to a maximum of 30 codes of rolling code (S2RP, S4RP, K-SLIM-RP, T-4RP) to be set freely on 3 channels.

The first channel directly commands the control board for opening the automatic device; the second channel commands a relay for a N.O. no-voltage output contact (terminals 19 - 20, max. 24V AC, 1 A) and the third channel controls directly the pedestrian opening from the controller.

LEARNING SYSTEM FOR RADIO CONTROL DEVICES

CH1 = 1st channel (OPEN/CLOSE) CH2 = 2nd channel CH1+ CH2= 3rd channel CH3 (PEDESTRIAN)

- 1_ Press button CH1 briefly to associate a radio control device with the OPEN/CLOSE function;
- 2_ the (green) DL2 LED is ON to indicate the code learning mode has been activated (if no code is entered within 10 seconds the board exits the programming function);
- 3_ press the button of the relative radio control device;
- 4_ the (green) DL2 LED turns off to indicate saving is complete and then on again immediately waiting for other radio control devices (if this is not the case, try to re-transmit or wait 10 seconds and restart from point 1);
- 5_ to memorise codes to other radio control devices, press the key to be stored on other devices within 2-3 sec. After this time (DL2 LED turns off) must repeat the procedure from point 1 (up to a maximum of 30 transmitters);
- 6_ if you wish to save on the 2nd channel, repeat the procedure from point 1 using the CH2 key instead of CH1 (in this case the DL2 LED is yellow);
- 7_ to program transmitters into the third channel, repeat procedure from point 1 using CH1 and CH2 buttons at the same time (DL2 will turn on red);
- 8_ to exit the learning mode without memorising a code, press button CH1 or CH2 briefly.



If the maximum number of radio controls is reached (30), the LED DL2 will begin to flash rapidly for about 3 seconds but without performing memorisation.

REMOTE PROGRAMMING BY MEANS OF T-4RP / K-SLIM-RP / S-2RP / S-4RP (V 4.X)

With the new version of software V 4.X it is possible to carry out the remote self-learning of the new version of transmitters T-4RP / K-SLIM-RP / S-2RP / S-4RP (V 4.X), that is without pressing the receiver's programming buttons.

It will be sufficient to have an already programmed transmitter in the receiver in order to start the procedure of remote programming of the new transmitters. Follow the procedure written on the instructions of the transmitter T-4RP / K-SLIM-RP / S-2RP / S-4RP (V 4.X).

CANCELLING CODES FROM RADIO CONTROL DEVICES

- 1_ Keep button CH1 pressed for 3 seconds in order to cancel all the associated radio control devices;
- 2_ LED DL2 flashes slowly to indicate that the cancellation mode has been activated;
- 3_ press button CH1 again for 3 seconds;
- 4_ LED DL2 turns off for approx. 3 seconds and then remains steady to indicate that the code has been cancelled;
- 5_ repeat the procedure from point 1 using button CH2 to cancel all the associated radio control devices;
- 6_ repeat procedure from point 1 using CH1 and CH2 buttons at the same time to erase all transmitters programmed into the third channel;
- 7_ to exit the learning mode without memorising a code, press button CH1 or CH2 briefly.

MEMORY CAPACITY

The code memory capacity* can be expanded from 30 to 126, 254 or 1022 codes (transmitters) by replacing the memory cards as follows (plug them onto J3 connector, see wiring diagram):

126	codes	Art.	250SM126
254	codes	Art.	250SM254
1022	codes	Art.	250SM1022

* Control units are supplied with a standard built-in 30-code memory. The memory card for enhancing the code memory capacity must be ordered separately.

To allow the previously stored codes (max. 30) to be moved to the control unit, it is required to install a memory card, making sure that the control unit is at that time off and that the memory card is brand new and therefore completely empty.

When the control unit is restarted, the codes will automatically move to the memory card.

Moving the codes from the control unit to the memory card does not work if on the memory card used, radio control codes have already been stored and the memory card has been subsequently erased.

To insert new radio controls, the operation described above shall be repeated.



WARNING: Control unit must be turned OFF to insert / remove a memory card.

RADIO MEMORY RESET:

- keep the CH1 and PROG keys pressed until the green DL1 and orange DL2 leds start flashing rapidly. At this point, release the keys and press them again until the LEDs go off, confirming that the operation is complete (if they are not pressed and you wait, the board returns to normal operation after about 12 seconds).

HARD RESET (factory setting):

- Keep the CH2 and PROG keys pressed until the green DL1 and the red DL2 LEDs start flashing quickly. At this point, release the keys and press them again until the DL1, DL2 and DL8 LEDs switch off. Release the keys; all the LEDs will turn off confirming that the operation is complete. After about 5 seconds the DL2 will start flashing red/green. If they are not pressed and you wait, the control unit returns to normal operation after 12 seconds. Upon restarting, it will be necessary to carry out the memorization procedure.



In case of Hard Reset the memory of the radio receiver will not be erased: all existing transmitters remain programmed.

11. SET-UP FOR OPERATION WITH TAU APPS

In order to use the TauApp and TauOpen apps, it will be necessary to connect to input J4 of the control unit using the supplied cable, the respective T-WIFI and T-CONNECT devices. To activate the operation of the apps see the respective instructions.

12. MALFUNCTIONS: POSSIBLE CAUSES AND SOLUTION

The automation does not start

- a- Check there is 230V AC power supply with the multimeter.
- b- Check, in the standard mode, that the NC contacts on the board are really normally closed (4 green LEDs on).
- c- Set dip-switch 6 (phototest) OFF.
- d- Increase the FR trimmer to the limit.
- e- Check that the fuses are intact with the multimeter.

The radio control has very little range

- a- Check that the ground and the aerial signal connections have not been inverted.
- b- Do not make joints to increase the length of the aerial wire.
- c- Do not install the aerial in a low position or behind walls or pillars.
- d- Check the state of the radio control batteries.

The gate opens the wrong way

Invert the motor connections on the terminal block, terminals 28 - 29 and terminals 23 - 24 (if used).

Inability to memorize a new remote control

- a- Reset the radio memory (paragraph 10).
- b- Check that the new and old remote control use the same technology.

13. GUARANTEE: GENERAL CONDITIONS

TAU guarantees this product for a period of 24 months from the date of purchase (as proved by the sales document, receipt or invoice).

This guarantee covers the repair or replacement at TAU's expense (ex-works TAU: packing and transport at the customer's expense) of parts that TAU recognises as being faulty as regards workmanship or materials.

For visits to the customer's facilities, also during the guarantee period, a "Call-out fee" will be charged for travelling expenses and labour costs.

The guarantee does not cover the following cases:

- If the fault was caused by an installation that was not performed according to the instructions provided by the company inside the product pack.
- If original TAU spare parts were not used to install the product.
- If the damage was caused by an Act of God, tampering, overvoltage, incorrect power supply, improper repairs, incorrect installation, or other reasons that do not depend on TAU.
- If a specialised maintenance man does not carry out routine maintenance operations according to the instructions provided by the company inside the product pack.
- Wear of components.

The repair or replacement of pieces under guarantee does not extend the guarantee period. In case of industrial, professional or similar use, this warranty is valid for 12 months.

MANUFACTURER'S DECLARATION OF INCORPORATION
(in accordance with European Directive 2006/42/EC App. II.B)

Manufacturer:
Address:

TAU S.r.l.
Via E. Fermi, 43 - 36066 Sandrigo (Vi) - ITALY

Declares under its sole responsibility, that the product:
designed for automatic movement of:
for use in a: *Residential/Apartment building use*

Electronic control unit
Sliding gates
complete with: *Radioreceiver*

Model: *K128MA*
Serial number:
Commercial name:

Type: *K128MA*
see silver label
Control panel for one 18V motor with encoder

Has been produced for incorporation on an access point (*sliding gate*) or for assembly with other devices used to move such an access point, to constitute a machine in accordance with the Machinery Directive 2006/42/EC.

Also declares that this product complies with the essential safety requirements of the following EEC directives:
- 2014/35/EU Low Voltage Directive **- 2014/30/EU Electromagnetic Compatibility Directive**

and, where required, with the Directive: **- 2014/53/EU Radio equipment and telecommunications terminal equipment**

Also declares that ***it is not permitted to start up the machine*** until the machine in which it is incorporated or of which it will be a component has been identified with the relative declaration of conformity with the provisions of Directive 2006/42/EC.

The following standards and technical specifications are applied:

EN 61000-6-2; EN 61000-6-3; EN 60335-1; ETSI EN 301 489-1 V1.9.2; ETSI EN 301 489-3 V1.6.1;
EN 300 220-2 V2.4.1; EN 12453:2000; EN 12445:2000; EN 60335-2-103.

The manufacturer undertakes to provide, on sufficiently motivated request by national authorities, all information pertinent to the quasi-machinery.

Sandrigo, 20/05/2022

Legal Representative

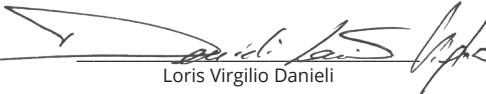
Loris Virgilio Danieli

Name and address of person authorised to draw up all pertinent technical documentation:
Loris Virgilio Danieli - via E. Fermi, 43 - 36066 Sandrigo (Vi) Italy



Via Enrico Fermi, 43 - 36066 Sandrigo (VI) - Italy
Tel +39 0444 750190 - Fax +39 0444 750376
info@tauitalia.com - www.tauitalia.com



Foglietto illustrativo

CARTA - Raccolta differenziata. Segui le indicazioni del tuo comune. (N.B.: togliere i punti metallici)



Instruction leaflet

PAPER - Waste separation. Follow the instructions of your city hall. (Note: remove the staples)